

# Workbenches & Shop Equipment







**Choice of Work Tops**

Tennsco offers five durable top styles that can be applied to any of our workbenches. Choose from Steel (A), Plastic Laminate (B), Hardwood Butcher Block (C), Compressed Wood (D), or Steel Top with Hardboard Laminate (E).

**1. Riser Options**

You can add a riser for an additional upper shelf that will keep your workspace less cluttered. Or, make it an electronic riser for convenient, additional power. (electronic riser shown)

**2. Back and Side Rails**

Keep nuts, bolts, screws and other small parts and tools confined to the work surface with Back and Side Rail options that prevent them from rolling away.

**3. Optional Casters**

Add mobility to your workbench. Caster kit includes two fixed and two locking swivel casters with 5" wheels.

**4. Optional Lower Shelf**

Provides extra storage space.

**5. Lockable Drawer**

Add lockable drawers to secure contents and keep necessary materials handy.



Note: shown with optional electrical outlet in leg.

**1. Roomy Workspace**

Large smooth surface available in various sizes to best fit your requirements.

**2. Optional A/C Power**

Knock-outs in legs allow for handy electrical outlets

**3. Stringer**

14 gauge stringer connects legs together for added stability. Shipped standard with all style tops.

**4. Sturdy and Durable**

Flared style legs provide a wide base for stability while allowing for knee room. Holes in feet permit bolting to the floor.

**5. Welded Construction**

Legs are made of heavy 13 gauge steel and welded into a one piece rigid framework. Adjustable legs are designed to support up to 5,000 lbs. per pair. Flared legs are designed to support up to 6,000 lbs. per pair.

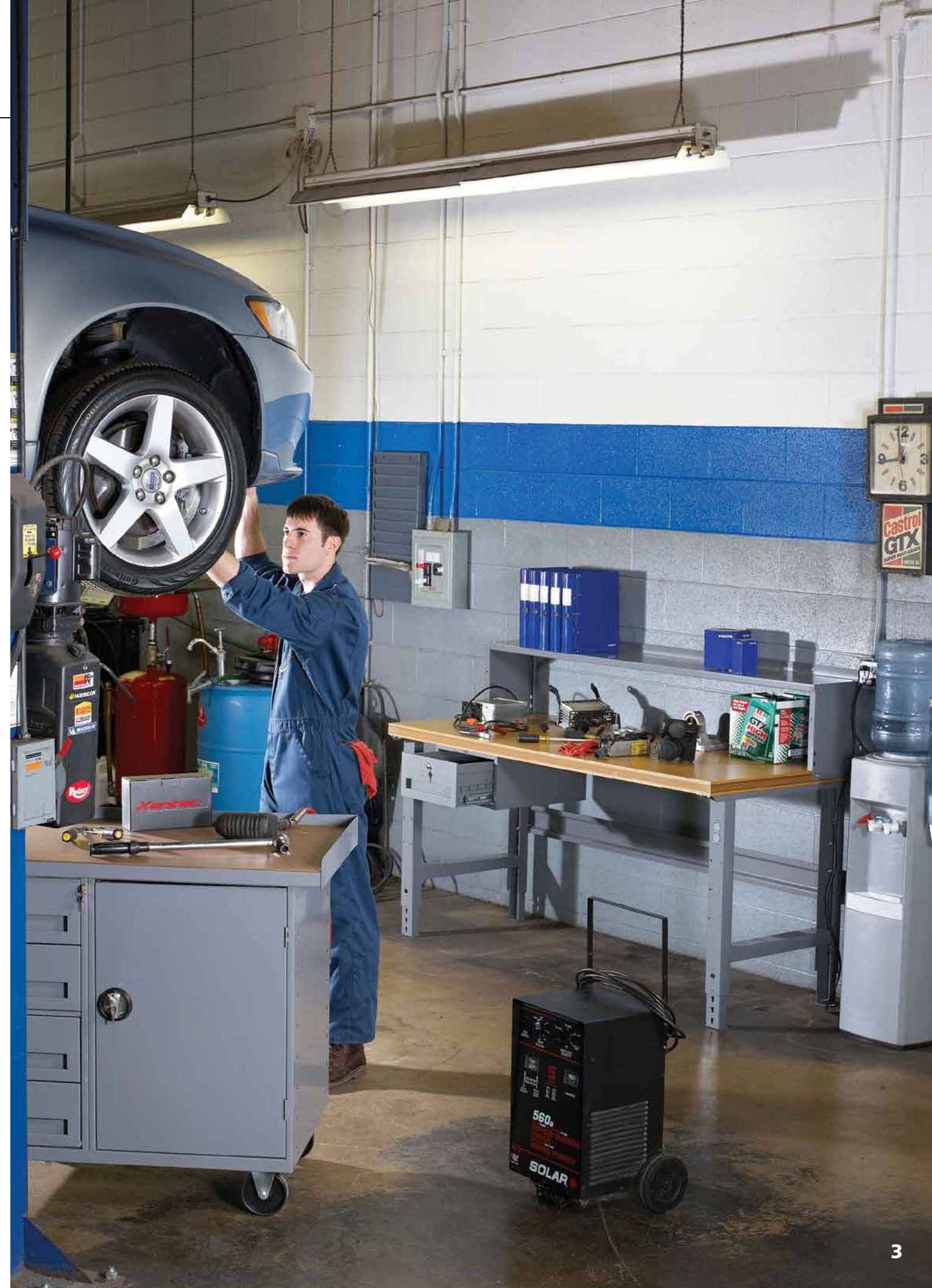
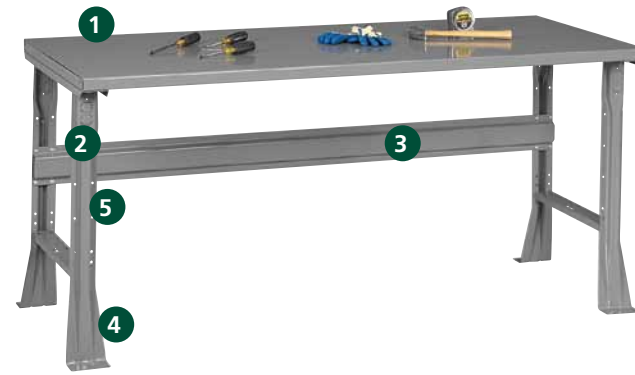



## All Purpose Workbenches

Tennsco Workbenches are constructed of only the finest materials and represent the hallmark of strength and durability. With legs made of heavy, 13 gauge steel designed to support up to 6,000 lbs per pair, strength is a priority. And with a complete selection of optional add-on components, including side and back rails, risers, stackable drawers and lower shelves, these highly efficient units insure maximum productivity in the workplace.

### OPTIONS



#### Stackable Drawers

Add lockable storage to our All Purpose Workbench with stackable drawers, which are easily mounted underneath the bench.

#### Riser Options

If your needs require additional shelf space or electrical power, risers are the solution. And, to add even more space, risers can be stacked.



#### Power in the Workbench Legs

Create a more productive work environment by adding power where you need it. Electrical outlets can be inserted into any leg. (Purchase electrical outlets at your local hardware store.)



#### Adjustable Legs

When your project requires varying heights simply add adjustable legs to your workbench. Legs adjust in 1 1/2" increments from 27 7/8" x 35 3/8".



#### Optional Power

Wiring kit can be installed in electronic risers and in electronic outlet panels. A power switch controls power to all four duplex outlets. Circuit breaker includes handy reset button.

### OPTIONS

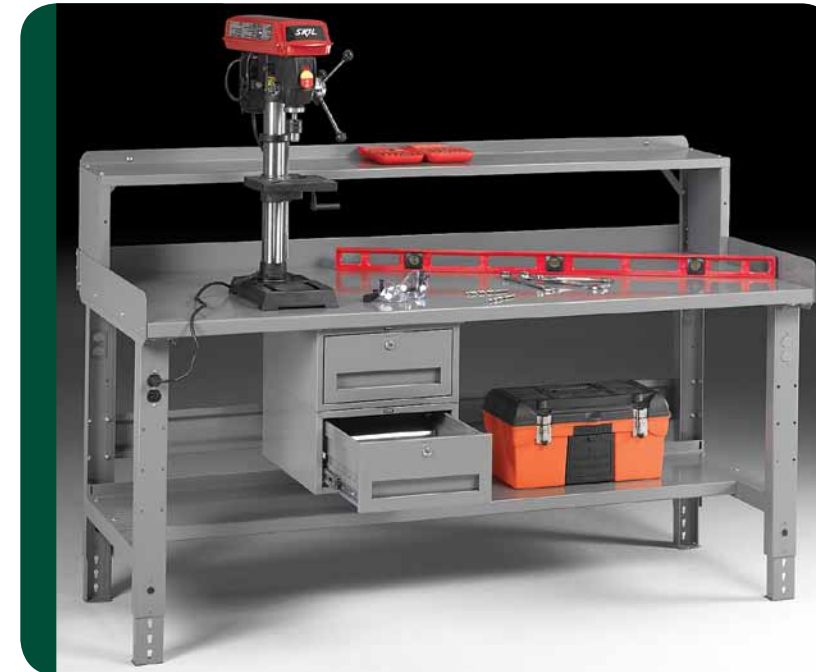

**Durability and Flexibility**  
Strength and conformity are coveted qualities in a productive workbench. With options such as added storage, handy electronics, increased work area and adjustable height legs your bench will truly become your own unique workspace.



#### Cantilevered Accessory System

Upright frames attach to the work surface to provide support for a variety of accessories such as task lights, sloped shelves, divider shelves and bin rails.

Note: Plastic bin boxes are not provided or sold by Tennsco.

## Workbenches with Modular Units

These 24" deep modular units come in either a cabinet or drawer style. They can be used separately or to support one of our standard tops.



- 1. Expandable**  
Pre-punched holes allow units to be bolted side-by-side.
- 2. Power at Your Fingertips**  
Optional 42" Wiring Kit can be added to 72" wide modular bench to provide convenient electrical service.
- 3. Roomy Drawers**  
Removable drawers extend completely for total access to each drawer's contents. Various combinations of standard and file drawers are available, see page 12.
- 4. Super Sturdy**  
Heavy gauge welded steel construction provides stability.
- 5. Lockable Storage**  
Modular units come standard with key locks. On drawer units, one lock secures all drawers.

### Choice of Work Tops

Tennsco offers five durable top styles that can be applied to any of our workbenches. Choose from Steel (A), Plastic Laminate (B), Hardwood Butcher Block (C), Compressed Wood (D), or Steel Top with Hardboard Laminate (E).



### FEATURES



**Locking Door**  
Cabinet door has lockable recessed handle. Great for storing valuable tools and testing equipment. Full sized shelf adjustable on 3" centers.



**Smooth Operations**  
Removable drawers feature a recessed handle for ease of use, while fully progressive, steel ball-bearing suspensions provide smooth, quiet operation.



### OPTIONS



**Options Designed to Fit Your Needs**  
Every application is unique ... that's why we offer a variety of components that truly make our Modular Benches modular. By adding risers, side and back rails, a lower shelf and more, you can create the perfect workbench to fit your needs.



# Electronic Workbenches

Tennsco's Electronic Workbenches feature a panel leg construction with the option of adding numerous electrical outlets, allowing for a variety of applications such as testing equipment and electronic component assembly.

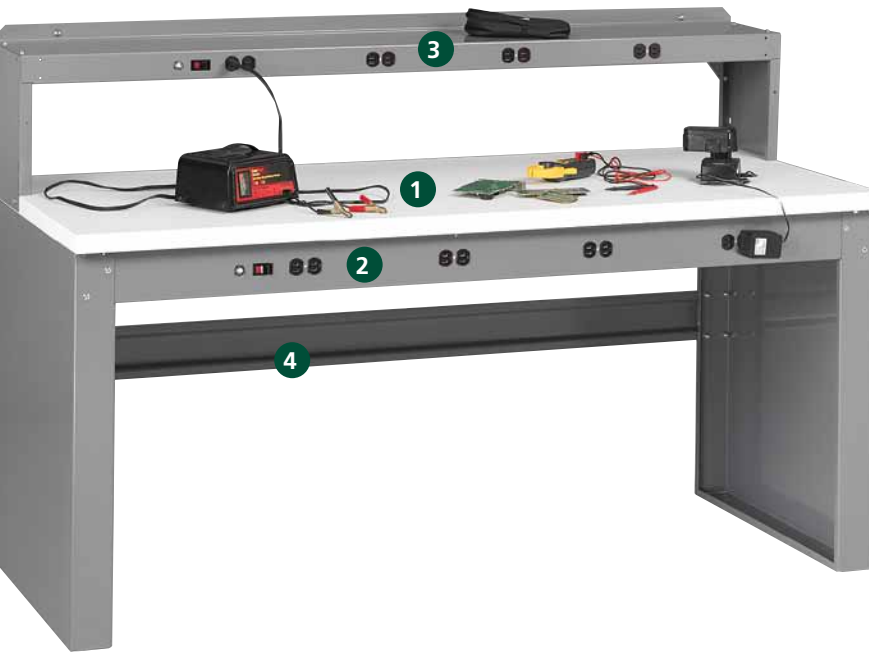

- 1. Smooth Work Surface**  
Our high pressure plastic laminate tops are a smooth non-conductive surface well suited for electronic assembly.
- 2. Power at Your Fingertips**  
Tops supported by complete steel framework. Front panel will accept four duplex electrical outlets.
- 3. Electronic Riser**  
Optional riser adds needed storage space and the ability to add electrical outlets at a convenient height.
- 4. Added Strength**  
All tops come with a channel-shaped stringer that ties legs rigidly together.

### Choice of Work Tops

Tennsco offers five durable top styles that can be applied to any of our workbenches. Choose from Steel (A), Plastic Laminate (B), Hardwood Butcher Block (C), Compressed Wood (D), or Steel Top with Hardboard Laminate (E).



### FEATURES



**Convenient Master Switch**  
Controls power to all four duplex outlets. Circuit breaker includes handy reset button.



**Contemporary Style Legs**  
Panel leg design features a sleek, closed end that is both functional and good looking.



### OPTIONS



**Drawers**  
Need more space? Drawers are the perfect solution and are easily mounted underneath wood topped workbenches with the use of Mounting Angles. (When mounting to a steel top workbench, Mounting Channels are needed.)



**Side and Back Rail Kit**  
Keep items placed on top of your workbench contained by using side and back rails. Rails are 3" high and are constructed of 16 gauge steel.

For additional accessories see pages 10-13

## Workbench Accessories



### Steel Top

Durable 12 gauge steel work surface reinforced with 14 gauge end channels. Smooth surface will not absorb oil or crack. Baked enamel finish resists rust.



### Plastic Laminate Top

High pressure white plastic laminate top and edges with particleboard core. Non-conductive smooth surface is ideal for electronics assembly.



### Hardwood Butcher Block Top

Solid laminated hardwood features butcher block construction to resist warp. Resandable surface is ideal for delicate machined parts and dies.



### Compressed Wood Top

Tempered hardboard top and bottom surface laminated to compressed wood core. Ideal for assembly work.



### Steel Top with Hardboard Laminate

Mechanically attached hardboard surface is economical, practical, sturdy, and durable.

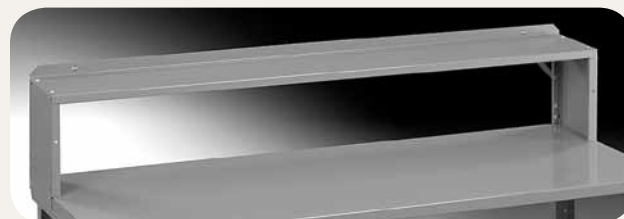

### Workbench Riser

Adds extra storage to workbenches for increased efficiency and convenience. Can be double stacked. Perfect for storing tools or test equipment at a convenient height. Risers are 16 gauge steel.



### Electronic Riser

Provides extra storage space plus convenient electrical service for power tools, test equipment, etc. Knockouts for four duplex receptacles and switch. Requires writing kit on page 13. May be double stacked.

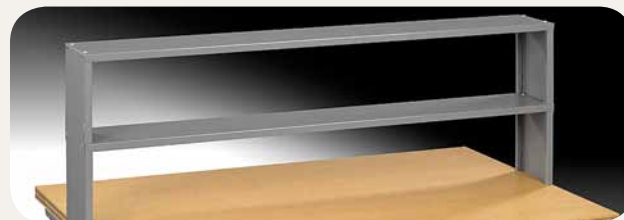

### Workbench Riser (Double Entry)

Extra storage for double entry workbenches with an added shelf. Risers are 16 gauge steel.

## Workbench Accessories

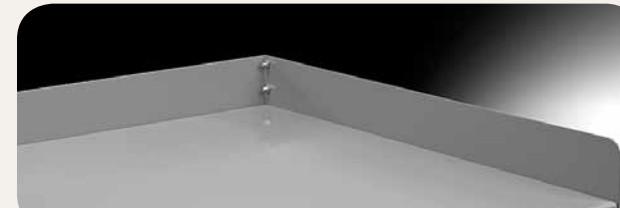

### Side and Back Rail Kit

3" height prevents parts and small objects from falling off sides and back. Rails bolt to any workbench top and can be used with other bench accessories. Rails are 16 gauge steel.



### Adjustable Legs

Now you can adjust workbenches to meet changing work requirements without replacing them. Adjust from 27 $\frac{1}{2}$ " to 35 $\frac{3}{8}$ " high in 1 $\frac{1}{2}$ " increments.



### Caster Kit

Add mobility to your workbench. Includes two fixed and two locking swivel casters with 5" wheels.



### Lower Shelf Full Depth (Double Entry)

A handy shelf/footrest attaches to double entry units for access from both sides. Stores parts, tools, and other needed items. Shelf is 16 gauge steel.

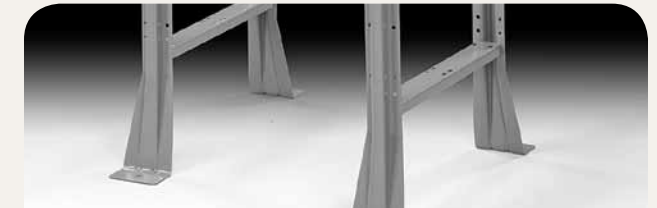

### Flared Legs

Flared legs are constructed of all welded 13 gauge steel with 14 gauge lower cross members. Available in three heights and three depths.



### Panel Legs

Box formed panel legs provide a sleek appearance. Features 16 gauge steel and pre-punched holes for easy attachment to all tops.



### Lower Shelf

Increases workbench storage space below work surface. Shelf is 16 gauge steel.

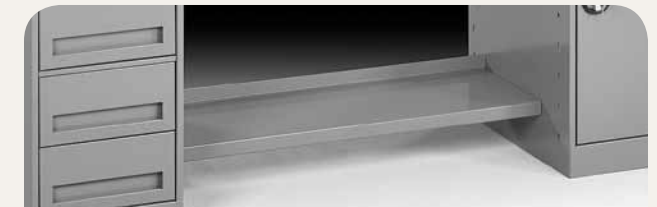

### Lower Shelf (Modular)

Convenient 16 gauge steel shelf for use on modular units.



## Workbench Accessories



### Stackable Drawer

Unit may be mounted on top of workbench or underneath. Multiple drawers may be bolted together for stacking. Drawer features fully progressive, steel ball-bearing suspensions for smooth operation, padlock hasp, drawer divider, removable tray and knock-out



for key lock. Add extra dividers for customized storage solutions.



### Wider Drawer Option

Store items at your fingertips by mounting a wider drawer under any workbench. Drawers glide effortlessly on fully progressive, steel ball-bearing suspensions, and provide a 70-pound capacity per drawer.



### Drawer Cam Lock

Provides convenient key lock to stackable drawers. Field installable. Available for both drawers.



### Modular Storage Cabinet

Storage cabinet comes standard with key lock. Cabinet is constructed of heavy gauge steel, and is welded for strength. Base raises opening above floor level. Additional shelves are available.



### Modular Four-Drawer Pedestal

Features four removable box drawers.



### Modular Three-Drawer Pedestal

Features two removable box drawers and one removable file drawer.



### Modular Two-Drawer Pedestal

Features two removable file drawers.

### Additional Features of all Drawer Pedestals

All box and file drawers feature a recessed handle and fully progressive, steel ball-bearing suspensions for smooth operation. Top box drawer comes with a plastic pencil tray. Box drawers come with one adjustable divider with card holder. File drawer comes with one compression divider. Gear lock simultaneously locks all drawers.

## Workbench Accessories



### Electronic Outlet Panel for Panel Leg Units

Provides mounting plate for four duplex outlets on panel legs. Wiring Kit sold separately.



### Electronic Outlet Panel for Modular Units

Provides mounting plate for four duplex outlets on Modular units. Wiring Kit sold separately.



### Cantilever Accessory System

Upright frames attach to the work surface to provide support for a variety of accessories such as task lights, sloped shelves, divider shelves and bin rails. (Plastic bin boxes are not provided or sold by Tennsco.)



### Wiring Kit

Comes complete with four duplex receptacles, on/off switch with pilot light, 8 foot grounded cord and plug, 15 amp, 115 volt service and circuit breaker. Prewired for quick installation. Use with electronic riser (pg. 10), outlet panels (above), or electronic workbench (pg. 8).

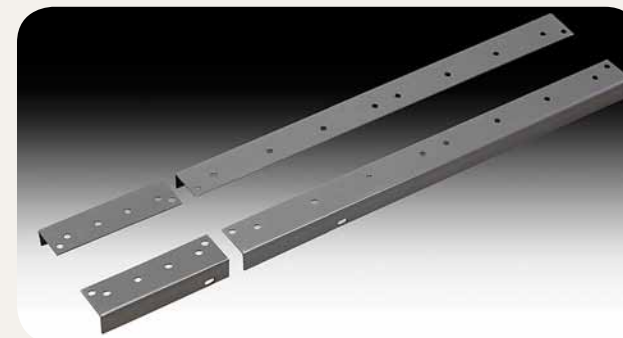

### Mounting Angles

Mounts stackable drawer unit under an electronic workbench. Pre-drilled holes and slots provide ease of assembly.



### Mounting Channels

Mounts either stackable drawer unit or modular cabinet to steel tops. Pre-drilled holes and slots for ease of assembly.

## Mobile Units

Designed to move heavy parts and tools to your worksite.

Mobile Workbenches feature all-welded construction from heavy gauge steel. Select from two styles.

### Mobile Workbench with Cabinet and Four Drawers



- 1. Smooth Surface**  
Steel Top with Hardboard Laminate provides a smooth work surface.
- 2. Drawer Lock**  
Comes with a gear lock to secure all drawers simultaneously.
- 3. Cabinet Shelf**  
Comes standard with one cabinet shelf; extra shelf for cabinet is also available.
- 4. Ample Drawer Space**  
Comes with four drawers on the left hand side. Each drawer comes with one adjustable divider with card holder.
- 5. Side and Back Guards**  
Side and back guards prevent items from rolling off top.
- 6. Lockable Cabinet**  
Protects valuable tools and equipment.
- 7. Wheel Locks**  
Comes with two fixed and two locking swivel casters for easy steering.

#### FEATURES



**Drawer Suspension**  
Fully progressive, ball-bearing suspensions allow drawers to glide easily and quietly.



**Secure Contents**  
Your contents remain safe with drawer and cabinet locks. Lock all drawers simultaneously with one turn of a key. A recessed handle lock secures all cabinet items.

### MOBILE WORKBENCH WITH CABINET AND ONE DRAWER



Mobile Workbench comes with a large, lockable storage cabinet unit with a shelf adjustable on 3" centers. Left side features a top drawer and an adjustable shelf for convenient access to contents.

#### FEATURES



**Locking Casters**  
Comes with two casters that swivel easily for maneuverability in tight spaces, but also lock when you need a stable base for working.



**Adjustable Shelves**  
Shelves adjust in three inch increments to allow you to modify your storage space to fit your needs.



# Modular/Mobile Workbenches\*

Now you can build a modular mobile workbench that fits your application needs! By selecting from numerous components you can decide whether to add power, where you need shelf space, and much more.



- 1. Risers**  
Delivers extra storage space above workbench and can feature added power.
- 2. Handle**  
A side handle provides smooth steering when moving the unit.
- 3. Bin Boxes**  
The 20-bin box compartment is ideal for storing a variety of smaller items. Each bin box also features a label holder to easily identify drawer contents.
- 4. Work Surface**  
Available with a 12 gauge steel top in two sizes to fit your needs.
- 5. Side & Back Rails**  
Keep items contained on your work surface.
- 6. Lockable Drawers and Cabinets**  
All drawers and cabinets feature locking mechanisms to keep items secure. Lock drawers with one turn of a key and secure cabinets with our recessed handle lock.
- 7. Casters**  
Two swivel and two fixed casters add mobility. Locks on swivel casters help to keep unit in place.

## CONFIGURE A MOBILE WORKBENCH THAT MEETS YOUR SPECIFIC REQUIREMENTS



## CHOOSE YOUR COMPONENTS



**Base**  
Start by choosing a 33" or a 48" wide base.

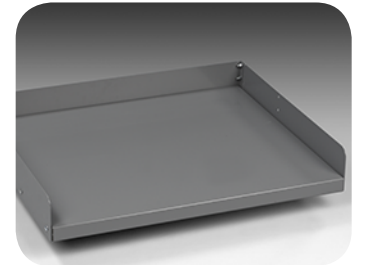

**Side and Back Rails**  
Keeps items from rolling off your top.



**Electronic Riser**  
Features four, close-at-hand, duplex receptacle outlets.



**Handle**  
Provides easy steering and maneuverability.



**Electronic Handle**  
Adds power at your fingertips.



**Three-Drawer Unit**  
Flexibility with two box drawers and one file drawer.



**Four-Drawer Unit**  
Lots of storage with four box drawers.



**Single Door Unit**  
Lockable storage cabinet with one adjustable shelf.

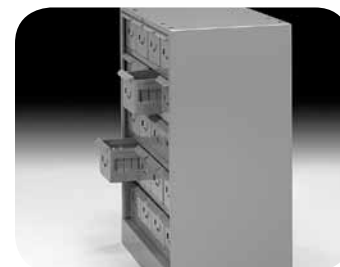

**Bin Boxes Unit**  
20-bin box compartment storing a variety of items.



**Double Door Unit**  
A double width, lockable storage cabinet with one adjustable shelf.

## Foreman's Desks

Foreman's desks provide a convenient yet sturdy writing surface with the added capability of storing a variety of supplies in a lockable cabinet. Ideal for the industrial workplace, businesses, schools and institutions. Available in both closed and open styles.

### Foreman's Desk Closed Style



- 1. Heavy Steel Construction**  
14 gauge corner posts and heavy steel construction assures long life.
- 2. Roomy Lockable Storage Cabinet**  
Large storage area with 3-point locking system boasts two shelves for storing tools and other supplies.
- 3. Additional Storage**  
Compartmentalized riser is perfect for storing writing utensils, forms and papers.
- 4. Sturdy Writing Table**  
Large sloping surface leaves plenty of room for paperwork and supplies.
- 5. Lockable Drawer**  
For easy access to additional supplies

#### FEATURES



##### Casters

When the job demands flexibility, a mobile version is available. Two rigid and two locking swivel casters give you plenty of mobility and stability once you've reached your destination. Casters on Foreman's Desks are available only at time of order; existing units can not be retrofitted with casters.



##### Secure Contents

Your contents remain safe with drawer and cabinet locks. Drawer and cabinet come standard with two keys each. A three point locking system secures all cabinet items.

### FOREMAN'S DESK OPEN STYLE



In situations where you don't need a lockable storage cabinet, the added leg room permits the use of a stool for seated comfort. The handy shelf can be used for storage of bulky items or as a footrest.

### WALL MOUNTED FOREMAN'S DESK



Add a handy work surface anywhere. Wall mounted desk is perfect anywhere especially where floor space is limited.

#### FEATURES



##### Drawer Suspension

Fully progressive, ball-bearing suspensions allows the drawer to glide easily and quietly.



##### Adjustable Shelves

Shelves adjust in 4 7/16" increments to allow you to modify your storage space to fit your needs.



## Service Carts

A valuable addition to any work area. Portable service carts with top and bottom trays to house an assortment of tools, parts, and odds and ends.



1. **Size Selection**  
Available in two different sizes to meet a variety of needs.
2. **360° Turning**  
Two fixed and two locking swivel casters with 5" wheels provide maximum steering control in confined areas.
3. **Tubular Push Handle**  
Push handle is rounded to allow for a firm, comfortable grip.
4. **Versatile Components**  
Top tray can be inverted to provide flat work surface.
5. **Flexible**  
Optional tray may be added to the cart anytime for additional storage.

### FEATURES



#### Reversible Shelf

Great for bringing all your tools to the work site. Everything is within reach and the top shelf can be reversed to serve as a work area allowing you complete access without restrictions from sides or edges.



#### Two sizes

Service carts come in two sizes to meet your needs. Choose from a 30" x 16" cart or a larger 36" x 24" version.

### OPTION



#### Additional Shelf

Greater storage and transportation capacity may be added by inserting an optional middle shelf. Maximize your productivity by making one trip to the work area when you have a lot of tools or parts to transport.

## PACKING TABLE

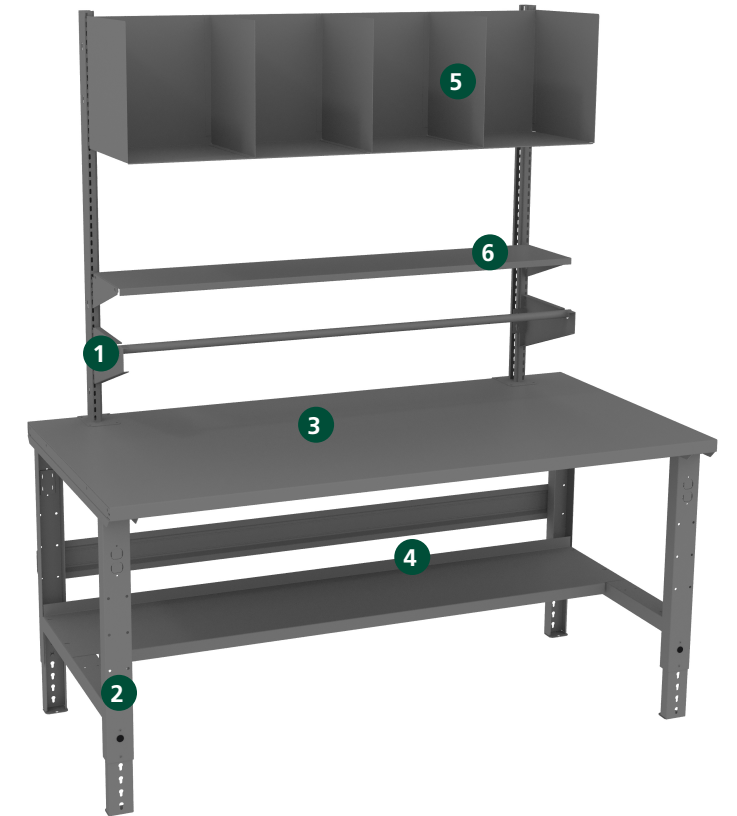

1. **Roll Dispenser**  
Ideal for holding rolls of packing materials.
2. **Adjustable Legs**  
Bench height is adjustable on 1 1/2" increments from 27 7/8" to 35 3/8".
3. **Choice of Top**  
1 1/2" steel or 1 3/4" butcher block tops available.
4. **14" Deep Lower Shelf**  
Easily accessible lower shelf allows for storage of bulky items.
5. **Convenient Divider Shelf**  
Perfect for storing boxes or oversized cartons.
6. **Eye Level Shelf**  
Perfect for storing items within arms reach.

### OPTIONAL ACCESSORIES

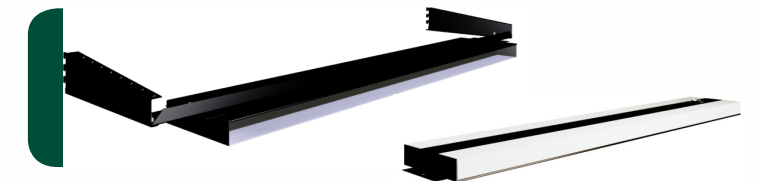

#### Task Light

Helps provide ample light across your entire workspace.

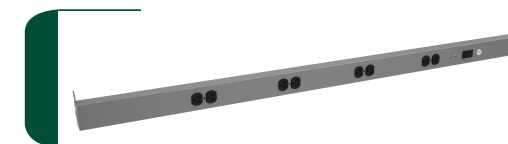

#### Power Rail



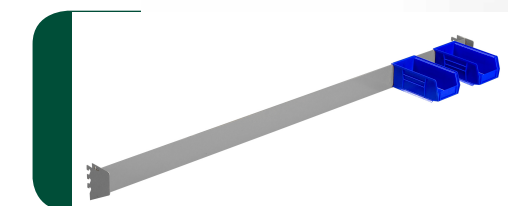

































Mounted power rail is very convenient for electric tools.



#### Bin Rail

Accommodates plastic or metal bins for storing parts. (Bins not sold by Tennsco).

**PRODUCT LINE OVERVIEW**

<b>STORAGE CABINETS</b>	 Deluxe	 Standard	 Jumbo	 C-Thru	 Specialty					
<b>BOOKCASES</b>	 13 1/2" Deep	 18" Deep	 Cabinet/Bookcase Combo							
<b>FILING</b>	 Card & Multimedia	 Fixed Shelf Lateral File	 Lateral File	 Imperial	 Fixed Shelf File	 Literature Sorter & 30 Drawers				
<b>LOCKERS</b>	 Standard	 Ventilated	 C-Thru	 Heavy-Duty	 Cubby					
<b>SHELVING</b>	 Bulk Rack	 ESP	 Q-Line	 Stur-D-Stor	 Regal	 Z-Line	 Archive Rack	 Capstone	 L&T	 Estey
<b>SHOP EQUIPMENT</b>	 All Purpose Workbench	 Electronic Workbench	 Modular Workbench	 Modular/Mobile Tool Cart	 Foreman's Desk	 Service Cart	 Packing Table			



Customer Service: (866) 446-8686 • [www.tennsco.com](http://www.tennsco.com) • [customerservice@tennsco.com](mailto:customerservice@tennsco.com)



**PROUDLY MADE IN THE U.S.A.**